

Hydrocarbon Filtration Products

- Fuel Filtration Vessels and Systems
- API/EI (IP) Qualified Cartridges
- Filtration Cartridges
- Fuel Dispensing Filtration
- Fuel Condition Monitors



Racor from the Refinery to the Nozzle	2-3
Hydrocarbon Filter Cartridges	4
Hydrocarbon Filter Vessels/ Systems and Cartridges	5
Hydrocarbon Filter Cartridges	6-9
FBO Filter Vessels	10
FBO Filter Cartridges	11
RVFS Series Vessels	12
RVFS Cartridges	13
Microfilter Vessels	14
Industrial Filter/Water Separator Vessels	15
API/EI 5th Edition Vessels	16
Fuel Monitor Vessels	17
Fuel Condition Monitors	18
Also Available from Racor	19
General Information	20
Parker Hannifin Corporation	21



Aviation

Microfilter Cartridges	6
Monitor Cartridges	8
Clay Bags and Canisters	9
Separator Cartridges	8
API/EI Qualified Coalescers	4 & 7
Microfilter Vessels	13-14
API/EI 5th Edition Vessels	16
Fuel Monitor Vessels	17



Fuel Dispensing

Microfilter Cartridges	6
Separator Cartridges	8
Coalescer Cartridges	4 & 7
Microfilter Vessels	13-14
RVFS 1, 2, 3 and Cartridges	12-13
FBO Housings and Cartridges	10-11



Marine

Microfilter Cartridges	6
Separator Cartridges	8
Coalescer Cartridges	4 & 7
Microfilter Vessels	13-14
RVFS 1, 2, 3 and Cartridges	12-13
FBO Housings and Cartridges	10-11



Oil Field

Microfilter Cartridges	6
Separator Cartridges	8
Coalescer Cartridges	4 & 7
Microfilter Vessels	13-14
FWS Housings	13 & 15

Refinery

Microfilter Cartridges	6
Clay Bags and Canisters	9
Separator Cartridges	8
Coalescer Cartridges	4 & 7
Microfilter Vessels	13-14
FWS Vessels	13 & 15





From the Refinery to the Nozzle

Over the last 37 years, Parker's Racor Division has become the most trusted name in the engine, mobile, marine and stationary fuel filtration and water separation industries. Racor now has standard products available to filter virtually any fuel at any flow rate and can configure systems to meet customers' requirements for application, environment and other specific parameters.





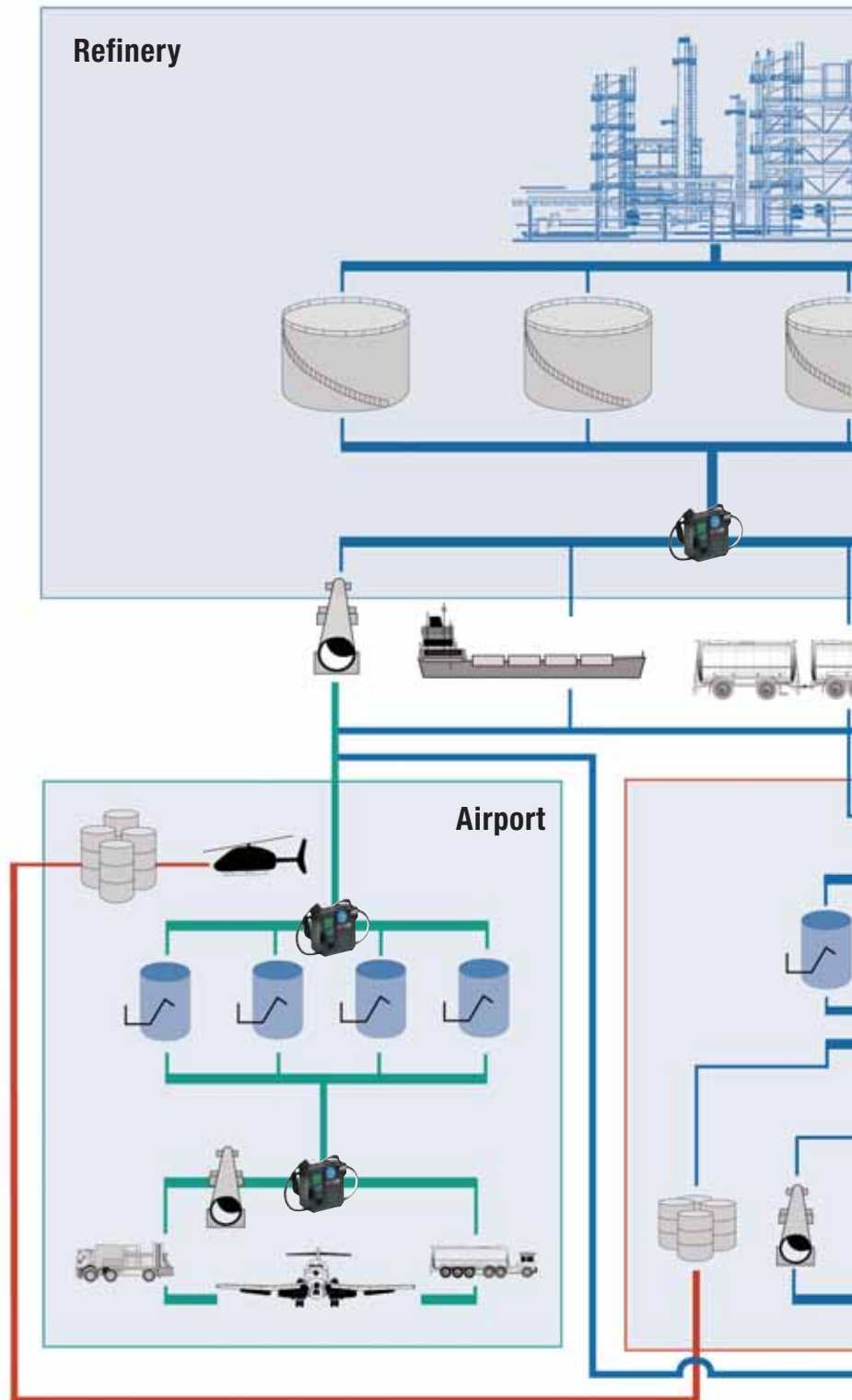



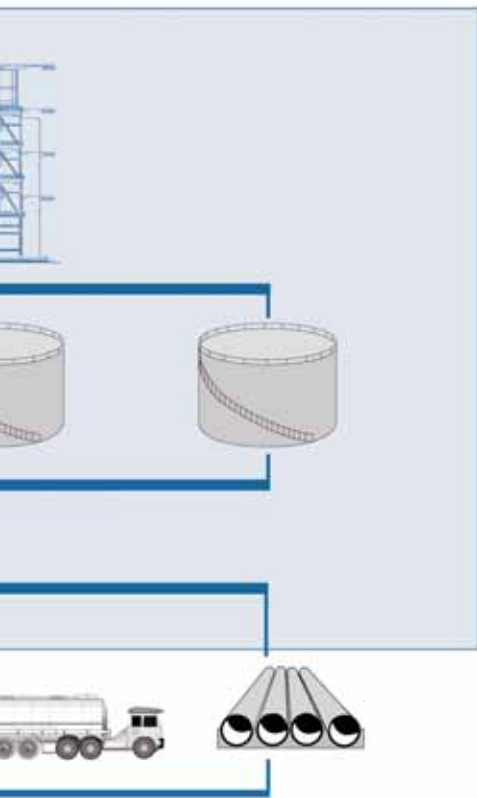



State-of-the-art, advanced technology fuel filtration laboratories are currently located in North America and Europe. A separate, dedicated 2,500 USGPM API/EI (IP) engineering test facility is located in the United States and future laboratories are planned for Asia and South America.

Racor has utilized its long-time experience in the fuel supply industry to produce the most advanced aviation fuel API /EI (IP) 1581-qualified filter/water separators, 1590-qualified microfilters and EI 1583-qualified monitors. Qualified vessels and a wide range of industry standard interchangeable products round out Racor's hydrocarbon fuel filtration product offering.



 Filtration requirements will vary depending on local fuel quality.



-  Multi-Product Pipeline
-  Dedicated Pipeline
-  Road Transport
-  Refueler
-  Dispenser
-  ACM 20
-  Sea Cargo
-  Aircraft
-  Helicopter
-  Fuel Drums
-  Fuel Storage
-  Floating Suction
-  Underground Storage

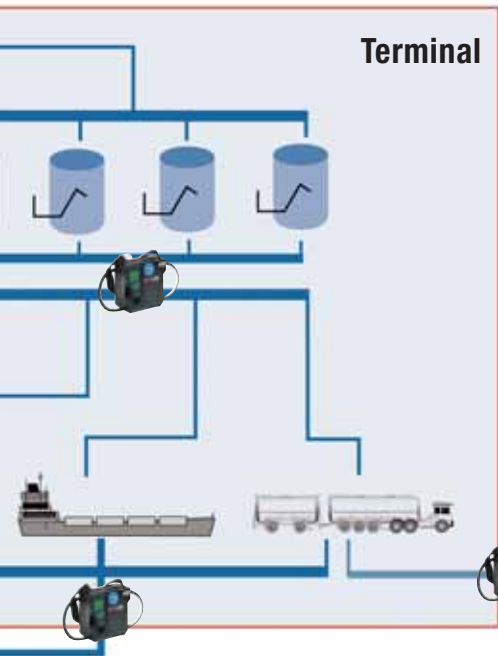

Terminal

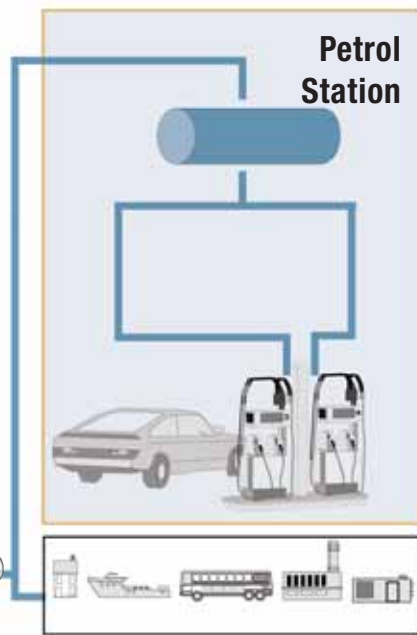

Petrol Station

Industrial & Marine Fuel Applications

MF Racor offers 2 types of Microfilters: FP Cellulose cartridges offer 95% filtration efficiency and are available in micron ratings of 1, 5, 10, 25, & 40, suitable for fuel and hydrocarbon applications. FS Synthetic high efficiency microfilter cartridges feature a water resistant, all synthetic media providing 99.7%+ efficiency at the stated 1, 5, 10, & 25 micron ratings complying to API/EI (IP) 1590 2nd Edition (1 and 5 micron). Requirements may differ depending on location and contamination history.



FWS Racor Hydrocarbon FWS series vessels use a 2 stage separation system. The first stage coalesces the fuel/water emulsion by means of high efficiency filter media combined with a resin impregnated fiberglass coalescing shell. The second stage uses a hydrophobic separator as a water drop barrier, allowing the clean dry fuel to pass. The coalesced water droplets are repelled by the hydrophobic barrier and are collected in the sump of the housing. A full range of standard and API/EI (IP) 1581 5th Edition qualified combinations are available. *NOTE: A full range of industrial vessels are available for other hydrocarbon products.*



RHFM Racor Horizontal Fuel Monitor Vessels with EI 1583 cartridges will absorb free water from fuels to <15 ppm as well as providing high filtration efficiency. Monitor cartridges are qualified to EI 1583.



RVFS This innovative filter vessel will accept a wide range of Microfilters, Coalescers and Separator cartridges. The vessel is particularly targeted at high volume diesel fuel delivery terminals and fueling stations.



FBO Offering a similar level of versatility as the RVFS, these filter vessels will accept a wide range of Microfilters, Coalescers/Separators and Monitor cartridges. The vessel is particularly targeted at medium volume fuel delivery systems, and offers an economical solution to fuel delivery.



ACM 20 Parker's renowned particle counter has been engineered and calibrated for use in fuels and allows quick, easy economical fuel condition checks for aviation and diesel fuels. A quick 2 minute test will allow you to check contamination levels, trends and integrity in a far more consistent, reliable and repeatable way than traditional clear and bright methods.



Filter Cartridges

Racor is a qualified supplier of API/EI (IP) 1581 (American Petroleum Institute/Energy Institute) and military standard aviation fuel coalescers and separators, EI 1583 monitors and API/EI (IP) 1590 microfilter cartridges. Racor aviation fuel filtration systems are used by customers worldwide to assure the delivery of clean, dry fuel. This same filter cartridge technology is used to remove water and solid contaminants from diesel, gasoline, liquid natural gas and other hydrocarbon fuels before they are transported, stored and used.

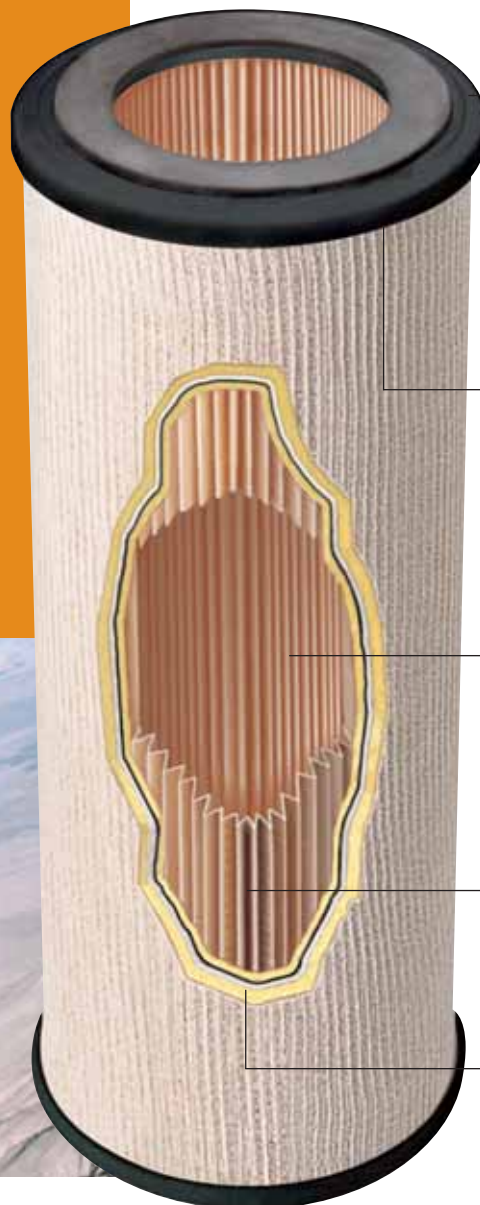

Injection molded nylon end caps assure tolerances equaled only in machined parts. Nylon resins eliminate corrosion problems and offer improved chemical and thermal performance, as well as excellent impact resistance.

State of the art adhesives are used to seal the filtration media to the end cap. This construction substantially improves the strength of the cartridges, in addition to having excellent resistance in a wide range of hydrocarbon environments.

Micronic first stage filtration combined with a resin impregnated glass coalescing bed that is self supporting (without metal components) withstands differential pressures of 75 PSID without structural failure.

Fiber blends and multiple layer media composition are designed specifically for each application.

State of the art fiberglass shell coalescing media.



Filter Vessels

Racor has expanded its filter vessel product line for refineries, pipelines, bulk storage terminals and airport refueling equipment. Vessels are designed and manufactured to ASME and API/EI (IP) and CE/PED qualifications.

Racor vessels, combined with Racor filter cartridges, offer customers finer filtration, cleaner, drier hydrocarbon products and extended cartridge change intervals. Extended change intervals offer more uptime and lower maintenance costs.

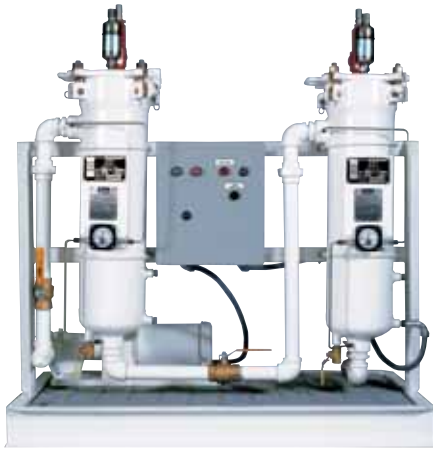

Filter Vessels and Cartridges Deliver the Ultimate in Protection and Reliability

For over 35 years, Parker Hannifin's Racor Division has been recognized as the global leader in fuel filtration and separation technology.



By utilizing the latest computer-aided design tools, the engineering team takes specific application requirements and quickly develops the necessary components to manufacture vessels and elements that meet industry codes and customer-specific requirements.

Racor's emphasis on advanced engineering is combined with a company-wide focus on uncompromising quality and premier customer service. This concentrated effort means that customers receive on-time delivery of the highest quality filtration systems available and that they meet the most demanding requirements for performance and service life.



FP Series Pleated Microfilter Cartridges

- Maximum surface area offers optimum contamination holding capacity.
- High flow rate, low initial pressure drop.
- Micron rating from 40 micron down to 1 micron.
- Cartridges to fit most popular industry filter vessels.
- Collapse pressure = 40 psid.
- pH range from 5 to 9.
- 160°F (71°C) maximum operating temperature.
- Flow direction = outside to in.
- Glass filled nylon end caps are standard, eliminating corrosion and offering excellent thermal stability and high impact resistance.
- Buna-N gaskets standard.

FS Series Synthetic Pleated Microfilter Cartridges

- 4 times the filtration surface area of comparable product available from competitors.
- 99.7% efficiency at stated element rating.
- Designed and tested to meet stringent requirements of API/IE (IP) 1590 Specifications and qualification procedures for aviation fuel microfilters. (Consult factory to obtain qualification test report).
- Micron ratings of 1 and 5 are designed, tested and qualified to API/IE (IP) 1590. 10 and 25 micron cartridges are available for industrial applications.
- Collapse pressure 75 psid.
- Glass-filled nylon end caps are designed as standard, eliminate corrosion and its byproducts. In addition they provide excellent thermal stability and impact resistance.
- Buna-N gaskets are designed as standard.
- PH range from 5 to 9.
- Designed to fit most popular filter vessels.
- Steel outer wrap available for back flow protection.





CP Series Industrial Coalescer Cartridges

- Available in standard industry diameters and lengths.
- Removes particulates and emulsified water from hydrocarbon fluids.
- Engineered single and multi-layered media increases contaminant holding capacity.
- Water removal to less than 15 ppm.
- Glass-filled nylon end caps are standard, eliminating corrosion and offering excellent thermal stability and high impact resistance.
- Maximum differential pressure = 75 psid.
- Maximum operating temperature = 160°F (71°C).
- pH range from 5 to 9.
- No perforated center tube allows 100% utilization of the coalescing media. This eliminates media blinding often found in conventional coalescer designs.
- Standard construction contains no metal components. This allows spent cartridges to be easily crushed or incinerated to reduce disposal costs.
- Buna-N gaskets standard.
- Solids removal in a variety of micron ratings: 1, 5, 10 & 25.

ACP/RAC Series Coalescer Cartridges



- 3rd and 5th edition qualified.
- ACP/RAC Series: Vertical and horizontal applications.
- ACP Series: Coreless, crushable and incinerable.
- ACP Series: No perforated center tube allows 100% utilization of the coalescing media.
- ACP Series: No metal components except stainless steel bolt on TB cartridges.
- Removes free and emulsified water and particulates from the jet fuel stream.
- Available in standard industry lengths.
- Solids removal down to 0.8 micron.
- Glass-filled nylon end caps are standard.
- Maximum differential pressure is 75 psid.
- Max. operating temperature is 160° F (71° C).
- pH range from 5 to 9.
- Buna-N gaskets are standard.

For details on cartridges, see bulletin numbers 7666 and 7674.

SS, ST, SP, RSS and RST Series Separator Cartridges



- API/EI (IP) 1581 qualified separator cartridges.
- Cartridges to fit standard industry vessels.
- Synthetic screen with 40 micron openings and hydrophobic media can be reused with appropriate inspection and cleaning.
- Teflon[®]-coated screen at 60 micron. Teflon[®] is reuseable with appropriate inspection and cleaning.
- Glass-filled nylon end caps are standard, eliminating corrosion, offering excellent thermal stability and high impact resistance.
- 160°F (71°C) maximum operating temperature.
- pH range from 5 to 9.
- SP series cartridges are available in industry standard lengths and micron ratings from 1 to 25 micron.

For details on cartridges see bulletin number 7667.



RMO and RMI Series Monitor Cartridges

Qualified to EI Specification 1583. Qualification for Aviation Fuel Filter Monitors.

- Qualified at less than 1 micron.
- Qualified at less than 15 ppm of water in the effluent.
- Qualified at less than 0.26 mg/liter of solids in effluent.
- Glass filled nylon end caps are standard eliminating corrosion and its by products in addition to having excellent thermal stability and impact resistance.
- Multi-layered media for maximum solids holding - with absorbent media cross linked to trap and hold free and emulsified water.
- Works in the presence of fuel additives and surfactants as specified in the EI Specification 1583 Qualification Procedure.
- Collapse strength exceeds 175 psi differential pressure.
- Dimensionally interchangeable with all 2" and 6" O.D. competitor cartridges.
- The 2" O.D. standard lengths 5", 10", 15", 20", 25" and 30".
- Designed to fit existing monitor vessels where 2" and 6" O.D. monitors are used.
- No metal components reducing disposal costs.



For more details on cartridges see bulletins 7665, 7664, 7663 and 7662.

Note: Not recommended for use in aviation fuels with FSII.

**FW Series
Water Absorbing Cartridges**

- Designed to fit most vessels sized for 5" x 13.5", 6" x 14", 7" x 18" and 8" x 22" cartridges.
- Micron ratings 1, 5, 10 and 25.
- Spin-on cartridges also available.
- Removes free and emulsified water to less than 15 ppm.
- Water absorbing capacity to four quarts depending upon cartridge size.
- Reduced flow rates or rapid differential pressure rise alert operators changeout is needed.



**HIF Series
Coreless Cartridges**

- Crushable filter cartridge has no metal components.
- Crushable cartridge, reduces disposal volume by up to 85%.
- Incinerable, consult local regulations.
- High flow rate, low initial pressure drop.
- Collapse pressure = 75 psid.
- pH range from 5 to 9.
- Maximum operating temperature: 160°F (71°C).
- Flow direction: outside to in.
- Glass filled nylon end caps are standard.
- Buna N gaskets standard.
- Recommended cartridge changeout 20 psid.
- Available in micron ratings of 1, 5, 10 and 25.

Clay Bags and Canisters

- Interior and exterior media migration barriers.
- Canisters or synthetic bags.
- No internal metal parts to corrode or pose a safety hazard.
- Buna-N gaskets.
- Interchangeable with standard industry 7" x 18" or 7" x 19" cartridges.



FBO Filter Assembly

Racors' FBO-10 and FBO-14 filter assemblies are designed to meet the toughest hydrocarbon refueling conditions and provide for ease of cartridge change outs.

The FBO assembly can be used on mobile refuelers or installed in refueling cabinets. The unit can also be used for diesel fuel dispensing pumps or as a primary fuel filter/water separator for large diesel engines.

The assembly features a locking ring collar, which attaches the filter housing to the aluminum die-cast filter head with four bolts. The slotted locking ring collar allows maintenance personnel to hand-loosen the four collar bolts, rotate and lower the bowl assembly for cartridge change outs. With new cartridge installed, simply raise the bowl and rotate into position on the locking ring and hand tighten evenly.

The closure hardware consists of stainless steel nuts, bolts and washers with metal hand knobs for ease of maintenance – one person can easily change the filter element. No wrenches or other special tools are required. 100 LB-IN torque is highly recommended.



Standard Design Features

- Die-cast aluminum head
- Steel filter bowl assembly
- Powder-coated components
- Locking ring collar, no V clamps
- 1 1/2" NPT Inlet and Outlet
- 10 bar @ 240° F max design pressure
- Manual drain valve
- Manual vent valve

Options

- Mounting bracket
- Sight glass
- Pressure diff. indicator
- Water Probe

Applications

- Diesel fuel, aviation gas, gasoline and kerosene

Installations

- Diesel fuel dispensing system
- Marine fuel docks
- Fuel systems on large diesel engines



UL listed versions are available as part numbers FBO-10-MA and FBO-14-MA. See bulletin 7694.

Performance Specifications

FBO-10	Maximum Flow Rats				Clean Dry	Change
	Flow Range	Diesel	Kerosene	Gasoline	Delta P	Delta P
Microfilter	5-50 GPM	20	40	50	**	20 PSI
Filter sep	5-30 GPM	12	25	30	**	15 PSI
Absorber	5-45 GPM	18	35	45	**	30 PSI
FBO-14	Flow Range	Diesel	Kerosene	Gasoline	Delta P	Delta P
Microfilter	10-75 GPM	30	60	75	**	20 PSI
Filter Sep	10-40 GPM	15	30	40	**	15 PSI
Absorber	10-70 GPM	26	55	70	**	30 PSI

** varies with fluid, temperature, free water content and flow rate. The same flow rates apply to the FBO-10-MA and FBO-14-MA.



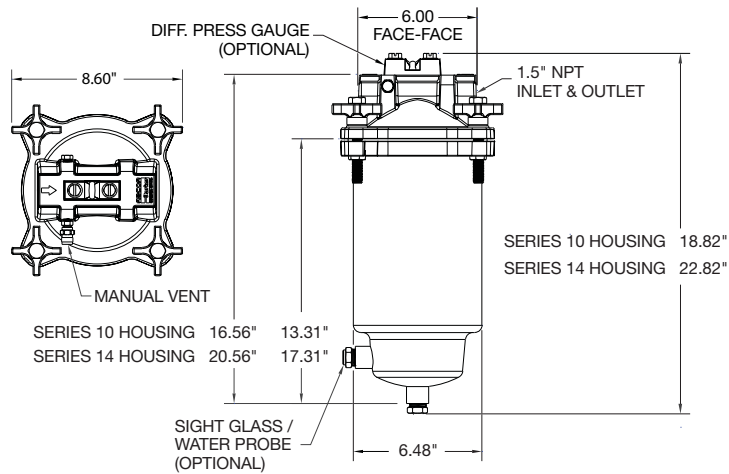

The versatile FBO-10 and the FBO-14 filter assemblies have three cartridge options to meet most field applications.

For refueling applications the filter separator cartridge is used.

The filter separator cartridge removes contaminants and water from kerosene, aviation gas, diesel fuel, gasoline and hydrocarbon fuels.

Silicon treated cellulose cartridges remove particle contaminants down to one micron.

Absorptive cartridges remove water and contaminants from fuel, oil or other hydrocarbon streams.

Review the cartridge chart on this page for field applications.

Cartridges

	Micron Rating	FBO-10	FBO-14
		6 x 10 Cartridge	6 x 14 Cartridge
Filter Separator	1	FB0-60327	FB0-60336
	5	FB0-60328	FB0-60337
	10	FB0-60353	FB0-60354
	25	FB0-60329	FB0-60338
Microfilter	1	FB0-60330	FB0-60339
	5	FB0-60331	FB0-60340
	10	FB0-60356	FB0-60357
	25	FB0-60332	FB0-60341
Absorptive Filter	1	FB0-60333	FB0-60342
	5	FB0-60334	FB0-60343
	10	FB0-60355	FB0-60358
	25	FB0-60335	FB0-60344





Features

- Carbon steel construction; other materials available.
- 250 psi ASME Code, Section VIII construction, stamped and certified.
- Yellow zinc-plated swing bolt closure.
- Buna-N o-ring cover seal.
- Interior: epoxy-coated MIL-C4556 E.
- Exterior: prime coated.
- Knife-edge cartridge mounting seals.

Connections

- Inlet and Outlet: 2 inch NPT.
- Main Drain and Liquid Level Ports: 1/2 inch NPT.
- Vent and Pressure Relief Connection: 3/4 inch NPT.
- Differential Pressure Gauge/Sample Ports: 1/8 inch NPT.

RVFS Series Vessels

The Racor RVFS Series filter vessels offer an unparalleled high efficiency, versatile, economical and low maintenance solution to many fuel delivery and industrial filtration applications. The vessels will accept Microfilters, Coalescer/Water Separator combinations and Monitor Water/Absorbers.

Used mainly in the diesel and kerosene re-fueling industry, these robust vessels can be seen on countless fuel dispensing locations providing clean dry safe fuel to modern diesel and heavy duty vehicles. Equally these vessels can be used for kerosene, AV gas, heating oils, gasoline and numerous other hydrocarbon fuels.

Optional Accessories

- Automatic air eliminator
- Pressure relief valve
- Differential pressure gauge
- Water level sight glass
- Manual water drain valve
- Support legs
- Wall mount brackets

Applications

- Diesel Fuel
- Kerosene
- Gasoline
- AV Gas

Vessel Dimensions inches

Vessel Series	RVFS-1	RVFS-2	RVFS-3
Height	39"/991 mm	51"/1295 mm	65"/1651 mm
Width	13.75"/350 mm	13.75"/350 mm	13.75"/350 mm
Depth	13.5"/343 mm	13.5"/343 mm	13.5"/343 mm
Dry Weight	101.4 lbs/46 kgs	114.6 lbs/52 kgs	103 lbs/59 kgs
Minimum overhead space required for element change	16"/406 mm	32"/813 mm	47"/1194 mm

RVFS Maximum Flow Rates

	Flow rate with 4 cSt -GPM Diesel			Flow rate with 2cSt Kerosene GPM Aviation Fuel			
	Coalescer	Microfilter	Monitor	Coalescer	Microfilter	Monitor	Clay
RVFS-1	6.6 GPM	66	29	50	66	58	N/A
RVFS-2	13.21 GPM	133	58	100	133	116	7/26.5
RVFS-3	19.81 GPM	200	87	150	200	174	14/53

Cartridge Options

FP Silicon Treated Pleated

	1 micron	5 micron	10 micron	25 micron
RVFS-1	FP-14601	FP-14604	FP-14605	FP-14607
RVFS-2	FP-30601	FP-30604	FP-30605	FP-30607
RVFS-3	FP-44601	FP-44604	FP-44605	FP-44607

Coalescer Cartridge Prefix OCP

	1 micron	5 micron	10 micron	25 micron	5 micron	10 micron	25 micron	Teflon
RVFS-1	OCP-15854	OCP-15858	OCP-15868	OCP-15878	SP-15404	SP-15405	SP-15407	ST-15401
RVFS-2	OCP-30854	OCP-30858	OCP-30868	OCP-30878	SP-30404	SP-30405	SP-30407	ST-30401
RVFS-3	OCP-44854	OCP-44858	OCP-44868	OCP-44878	SP-44404	SP-44405	SP-44407	ST-44401

Separator Cartridge Options

For additional information please consult the RVFS installation handbook, Part No. 7563.

RVFS Series Cartridges



Coalescer/Separator

Coalescer and separator mounted in the RVFS housing. Fluid/fuel is passed from the outside of the coalescer to the inside. The coalescer cartridge provides primary filtration of the fuel as well as coalescing free water from it. The clean fuel passes through the separator barrier and into the outlet of the housing. The coalesced water droplets are repelled by the hydrophobic barrier and are collected in the sump of the housing. The sump should be drained daily.

When ordering an RVFS for Coalescer/Separator installation kit number 72153-1, 72153-2 or 72153-3 is required.

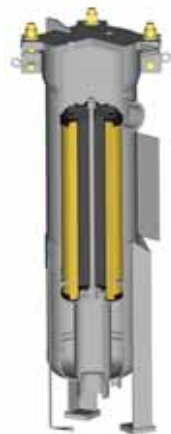

FP Cartridge Installation

Mounting shown – Racor's cellulose FP microfilter series. These elements offer 95% filtration efficiency of particulates and are available in micron ratings of 1, 5, 10, 25 & 40.

When ordering a RVFS for FP installation the kit number 73193-1, 73193-2 or 73193-3 is required.

Connections

- Inlet and Outlet:
2 inch NPT
- Main Drain and Liquid Level
Ports: 1/2 inch NPT
- Vent and Pressure Relief
Connection: 3/4 inch NPT
- Differential Pressure Gauge/Sample
Ports: 1/8 inch NPT

FS Cartridge Installation



Mounting shown – Racor's patent pending FS synthetic microfilter series. The microfilter features a water resistant, all synthetic media and provides 99.7% + efficiency at the stated 1, 5, 10 & 25 micron ratings.

When ordering a RVFS for FS installation kit number 73193-1, 73193-2 or 73193-3 is required.

Features

- Carbon steel construction.
- ASME code Section VIII construction, stamped and certified. CE certified vessels available.
- Zinc plated swing bolt closure.
- Buna-N o-ring cover seal.
- Interior epoxy coated MIL C4556E, exterior prime coated.





Microfilter Vessels

The RVMF Series Vertical Vessels are used with Racor Hydrocarbon FP, FS, and HIF coreless, high efficiency microfilter series cartridges. Racor hydrocarbon filter housings are designed for removing solid contaminants such as dirt, rust, pipe scale and other types of solids from fuels. Racor hydrocarbon vessels are designed for a single pass through the high efficiency cartridges providing clean product downstream.

Applications

- Jet A, Jet A1
- JP4, JP5, JP8
- Diesel Fuel
- Kerosene
- Gasoline
- Bio-Diesel

Optional Accessories

- Automatic air eliminator
- Differential pressure gauge
- Pressure relief valve
- Manual drain valve
- Sampling probes
- Liquid level sight glass

Standard Vertical Microfilter Vessels

Model No.	Jet Fuel	Diesel
	gpm	gpm
RVMF-400-2-44	400	200
RVMF-600-3-44	600	300
RVMF-800-4-44	850	425
RVMF-1200-4-44	1200	600

Features

- Carbon steel construction.
- 150 psi ASME Code, Section VIII construction, stamped and certified.
- Zinc-plated swing bolt closure.
- Buna-N o-ring cover seal.
- Hydraulic jack cover lift furnished on 14 inch and larger vessels.
- HIF center tubes when required.
- Inlet and outlet permanently marked.
- Interior: epoxy-coated MIL-C-4556 E.
- Exterior: prime coated.
- Knife-edge cartridge mounting seals.
- Rod mount cartridge hardware.



Industrial Filter/Water Separator Vessels

The RVFS Series Filter/Water Separator Vessels are for use with Racor Hydrocarbon ACP, RAC and CP Series Coalescers and SP, SS, ST, RSS and RST Series Separator Cartridges. Racor hydrocarbon RVFS Series two-stage vertical coalescer/separator housings are designed to filter solids and separate water from fuel. Using the correct combination of Racor hydrocarbon coalescer cartridges and second stage separator cartridges will provide the highest degree of water and solids removal.

Applications

- Diesel Fuel
- Kerosene
- Gasoline
- Bio-Diesel

Installations

- Refineries
- Terminals
- Loading racks
- Marine fuel sites
- Fuel storage
- Fuel pipelines

Connections

- Inlet and Outlet: 150# RF (ANSI) flanged
- Main Drain: NPT
- Vent and pressure relief connection: NPT
- Differential pressure gauge/sample ports: NPT

Features

- Carbon steel construction; other materials available
- ASME Code, Section VIII construction, stamped and certified
- Zinc plated swing bolt closure
- Buna-N o-ring cover seal
- Hydraulic jack cover lift
- Inlet and outlet permanently marked
- Interior: epoxy-coated MIL-C-4556 E
- Exterior: prime coated
- Knife-edge cartridge mounting seals

Optional Accessories

- Automatic air eliminator
- Pressure relief valve
- Differential pressure gauge
- Sampling probes
- Manual or automatic water drain valves
- Sump drain line heaters
- Liquid level sight glass
- Water slug control valve
- Pilot control valve
- Rate of flow control valve



Vertical Industrial Coalescer/Separators (FWS) Paper Separators

Model	Flow Rate	
	Diesel (gpm)	Kerosene (gpm)
RVFS-244-233	135	200
RVFS-344-333	200	300
RVFS-444-333	270	400
RVFS-556-444	420	600
RVFS-656-544	500	800
RVFS-856-644	670	1000
RVFS-956-744	750	1200



Features

- Carbon steel construction; other materials available
- ASME Code, Section VIII construction, stamped and certified
- Zinc-plated swing bolt closure
- Buna-N o-ring cover seal
- Hydraulic jack cover lift
- Inlet and outlet permanently marked
- Interior: epoxy-coated MIL-C-4556E
- Exterior: prime coated
- Knife-edge cartridge mounting seals

API/EI (IP) 1581 5th Edition Vertical and Horizontal Filter/Water Separator Vessels

The RVFS/5 Series Filter Water Separator Vessels are for use with Racor Hydrocarbon ACP and RAC Series Coalescers and SS, ST, RSS and RST Series Separator Cartridges. Racor hydrocarbon RVFS/5 Series two-stage vertical and horizontal coalescer/separator housings are designed to filter solids and separate free water from jet fuel. Using the correct combination of Racor hydrocarbon coalescer cartridges and second stage separator cartridges will provide the highest degree of water and solids removal.

Applications

- Jet A, Jet A1
- JP4, JP5, JP8
- Kerosene

Optional Accessories

- Automatic air eliminator
- Pressure relief valve
- Differential pressure gauge
- Sampling probes
- Manual or automatic water drain valves
- Sump drain line heaters
- Liquid level sight glass
- Water slug control valve
- Pilot control valve
- Rate of flow control valve

Installations

- Refineries
- Terminals
- Loading racks
- Hydrant carts and refuelers

Connections

- Inlet and Outlet: 150# RF (ANSI) flanged
- Main Drain: NPT
- Vent and pressure relief connection: NPT
- Differential pressure gauge/sample ports: NPT



API/EI (IP) 5th Edition Vertical Coalescer Separators (fws)

Model No.	Jet Fuel Flow Rates (gpm)
RVFS-5-100	100
RVFS-5-200	200
RVFS-5-300	300
RVFS-5-400	400
RVFS-5-600	600
RVFS-5-800	800
RVFS-5-1000	1000
RVFS-5-1200	1200



API/EI (IP) 5th Edition Horizontal Coalescer Separators (fws)

Model No.	Jet Fuel Flow Rates (gpm)
RVFS-5-100	100
RVFS-5-200	200
RVFS-5-300	300
RVFS-5-400	400
RVFS-5-600	600
RVFS-5-800	800
RVFS-5-1000	1000
RVFS-5-1200	1200



Fuel Monitor Vessels

The RHFM Series Horizontal Fuel Monitor Vessels, equipped with the RMO-2 inch Series Fuel Monitor cartridges, monitor the entire flow of fuel, collecting solids, absorbing water and ensuring only clean and dry fuel for delivery.

Racor Hydrocarbon RMO-2 Inch Series Monitor Cartridges are qualified to the latest edition of EI Specifications 1583 Qualification Procedures.

Applications

- Jet A, Jet A1
- JP4, JP5, JP8
- Diesel Fuel
- Kerosene

Optional Accessories

- Automatic air eliminator
- Pressure relief valve
- Differential pressure gauge
- Sampling probes
- Manual drain valve
- Cover inter-lock safety device

Features

- Carbon steel construction
- ASME Code, Section VIII construction, stamped and certified
- Zinc plated bolt closures
- Buna-N o-ring cover seal
- Cartridge spider assembly
- 225 PSI deckplate hydrotest
- Interior: epoxy-coated MIL-C-4556 E
- Exterior: prime coated
- Multi-position inlet connection and mounting saddles

Note: Not recommended for use in aviation fuels with FSII.

Standard Housing Data and Flow Rates

Model	Flow Rate		Required Cartridges		Liquid Volume		Dry Weight	
	gpm	lpm	qty.	Model	gallons	liters	lbs.	kgs.
RHFM-A-200	200	757	10	RMO-220-4	7 1/2	28	324	147
RHFM-A-300	300	1136	10	RMO-230-4	10	38	362	164
RHFM-A-600	600	2271	20	RMO-230-4	20	76	395	179
RHFM-A-900	900	3407	30	RMO-230-4	30	114	470	213
RHFM-A-1200	1200	4542	40	RMO-230-4	40	151	503	228

Weights and volumes are approximate.

Dimensional Data

Model	Inlet/Outlet		Dimensions*														Cover Type
			A		B		C		D		E		F		G		
	in.	mm	in.	mm	in.	mm	in.	mm	in.	mm	in.	mm	in.	mm	in.	mm	
RHFM-A-200	3	76	8 5/5	219	39	991	6	152	8	203	7 1/2	191	13	330	19	483	Flat
RHFM-A-300	3	76	8 5/8	219	49	1245	6	152	8	203	7 1/2	191	13	330	29	737	Flat
RHFM-A-600	4	102	12 3/4	324	51	1295	7	152	10	254	10	254	14	356	28	711	Flat
RHFM-A-900	6	152	14	356	53	1346	7	178	11	279	10	254	15	330	26	660	Flat
RHFM-A-1200	6	152	16	406	54	1372	7	178	11	279	11	279	15	330	26	660	Flat

*Dimensions are reference only. For exact dimensions, request drawing for applicable model number.



Features

- Particle counting has been in lab environments since the 1960's.
- Recognized as an industry approved method.
- Counts particulate distribution in hydrocarbon fuels.
- Conforms with ISO standards.
- Lab performance in the field.
- Small, portable and self powered data storage.
- Dynamic 2 minute test procedure.
- Simple operation.
- Calibration to ISO standards (ISO 11171).
- Particle counts per ml.
- Sample particle distribution analysis.
- Connects to existing aviation sampling points.
- Can also be used for testing of other fuel samples (such as diesel) with the optional Oil Delivery Pump kit.

Fluid Condition Monitors

Current practice in the aviation industry is to use a visual, 'clear and bright' test to make sure that the fuel being supplied from our refineries is free from solid matter and undissolved water at normal ambient temperatures.

This test is subjective and cannot detect those contaminants that can really do damage to the engine and its critical tolerance fuel control components.

Applications

- Determination of particle size distribution for filter testing.
- Determination of system cleanliness.
- Filter performance monitoring.





Hydraulic Filtration Systems

Parker Filtration's global reputation as a reliable supplier of superior hydraulic and lubrication filtration products, fluid power products and fluid condition monitoring equipment, is the result of a focused and integrated development and manufacturing system. A range of products that cover many markets and most applications.



Marine Filtration Systems

It's easy to see why Parker Racor is the most trusted name in marine filtration. Experienced sailors and marine system designers know that a fuel filter failure can stop a craft dead in the water. For nearly four decades, Racor has designed and manufactured diesel fuel filter/water separators that represent the standard in the marine industry.

Engine Air Filtration Systems



Fresh air. That's what Racor air filtration is all about. Because when engines breathe easier they perform better – with more power, more torque and with improved fuel economy. The Racor lineup includes heavy duty air cleaners and pre-cleaners, crankcase ventilation, marine filter/silencers, cabin air filters and replacement filters.

Engine Crankcase Ventilation Filter Systems



Mobile Fuel and Filtration Systems



Parker Racor fuel and oil filtration systems provide quality protection for engines operating in any environment, anywhere in the world. Racor's tried and trusted range of Spin-On fuel filter/water separators and the legendary Turbine Series represent, to customers, OEMs and end users alike, the very best in fuel filtration solutions.

DISTRIBUTED BY:



***BOLLAND
MACHINE***

A DIVISION OF DIESEL ENGINE PARTS WAREHOUSE INC.

**Contact Us for Product Information
or to Place an Order**

Phone 724-846-1290

Fax 724-846-5253

Email *kevin@bollandmachine.com*

Address 2718 Darlington Road
Beaver Falls, PA 15010

www.bollandmachine.com